

Side Channel Analysis and Embedded Systems Impact and Countermeasures



Job de Haas

Black Hat Europe 2008

- **Advances in Embedded Systems Security**
 - From USB stick to game console
 - Current attacks
 - Cryptographic devices
- Side Channels explained
 - Principles
 - Listening to your hardware
 - Types of analysis
- Attacks and Countermeasures
 - Breaking a key
 - Countermeasures theory
 - Practical implementations

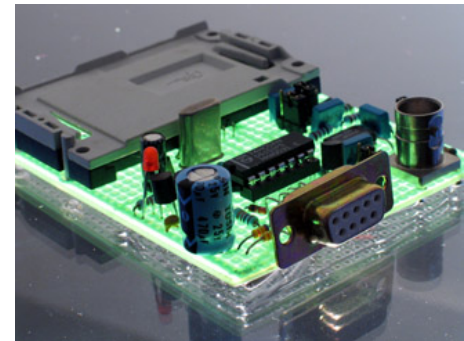

Security in embedded systems



- Preventing **debug** access
 - Fuses, Secure access control
- Protecting **buses and memory** components
 - Flash memories with security, DRAM bus scrambling
- Increase in **code integrity**
 - Boot loader ROM in CPU, Public key signature checking
- Objectives:
 - Prevent running unauthorized code
 - Prevent access to confidential information
 - **Effective** against most “conventional” attacks

Popular 'hardware' attacks

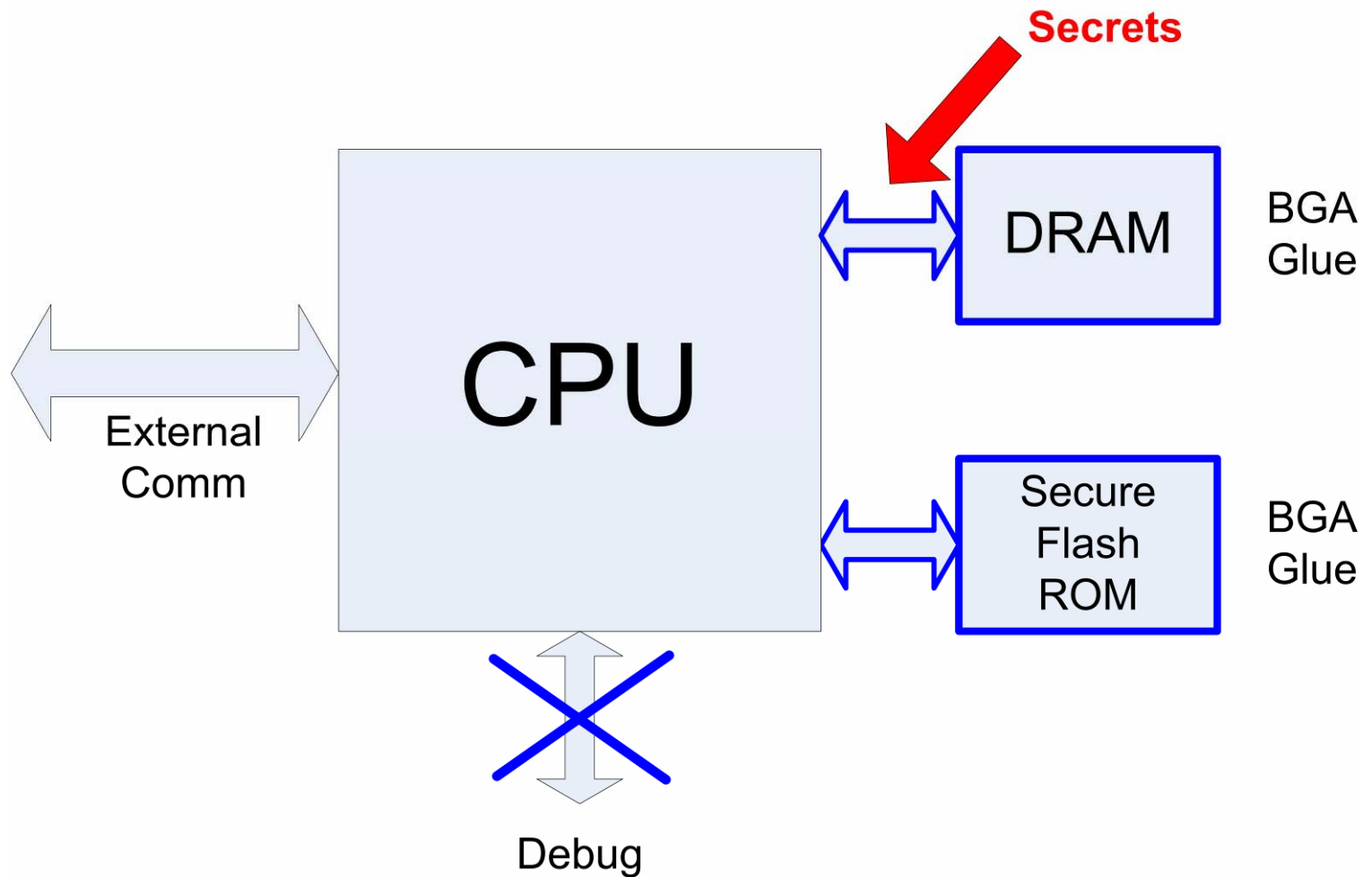

- **Smart cards** represent the ultimate cryptographic device:
 - Operate in a hostile environment
 - Perform cryptographic operations on data
 - Harnessing both the cryptographic operation and the key
 - Tamper resistant
- General purpose processors are **incorporating** more and more smart card style security
- Why **not use** a smart card?
 - Also adds complexity
 - How to communicate securely with it?
 - Some do (PayTV, TPM etc)

- Advances in Embedded Systems Security
 - From USB stick to game console
 - Current attacks
 - Cryptographic devices
- **Side Channels explained**
 - Principles
 - Listening to your hardware
 - Types of analysis
- Attacks and Countermeasures
 - Breaking a key
 - Countermeasures theory
 - Practical implementations

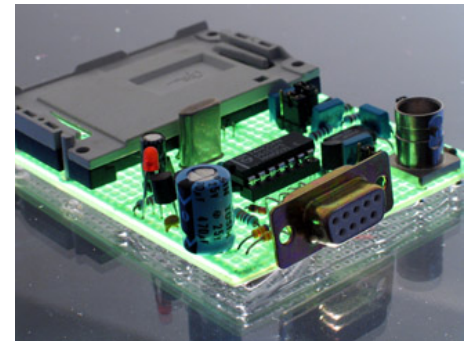

- What?
 - read 'hidden' signals
- Why?
 - retrieve secrets
- How?
 - Attack channels
 - Methods
 - Tools

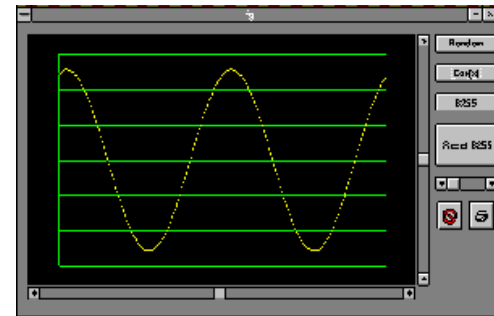

- Time



- Power consumption

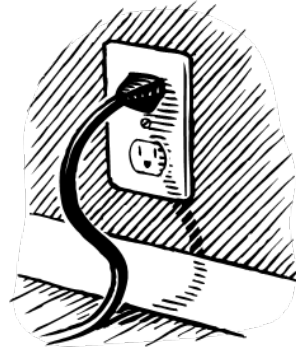

- Electro-Magnetic radiation



- Light emission



- Sound



- **Passive** attacks
 - Only observing the target
 - Possibly modifying it to execute a specific behavior to observe
 - **Examples:** time, power or EM measurements
- **Active** attacks
 - Manipulating the target or its environment outside of its normal behavior
 - Uncovering cryptographic keys through 'fault injection'
 - Changing program flow (eg. circumvent code integrity checks)
 - **Examples:** Voltage or clock glitching, laser pulse attacks

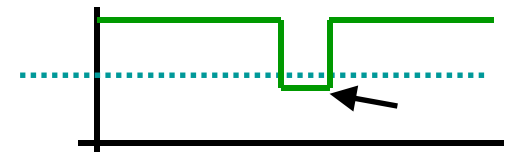

Principle of timing analysis

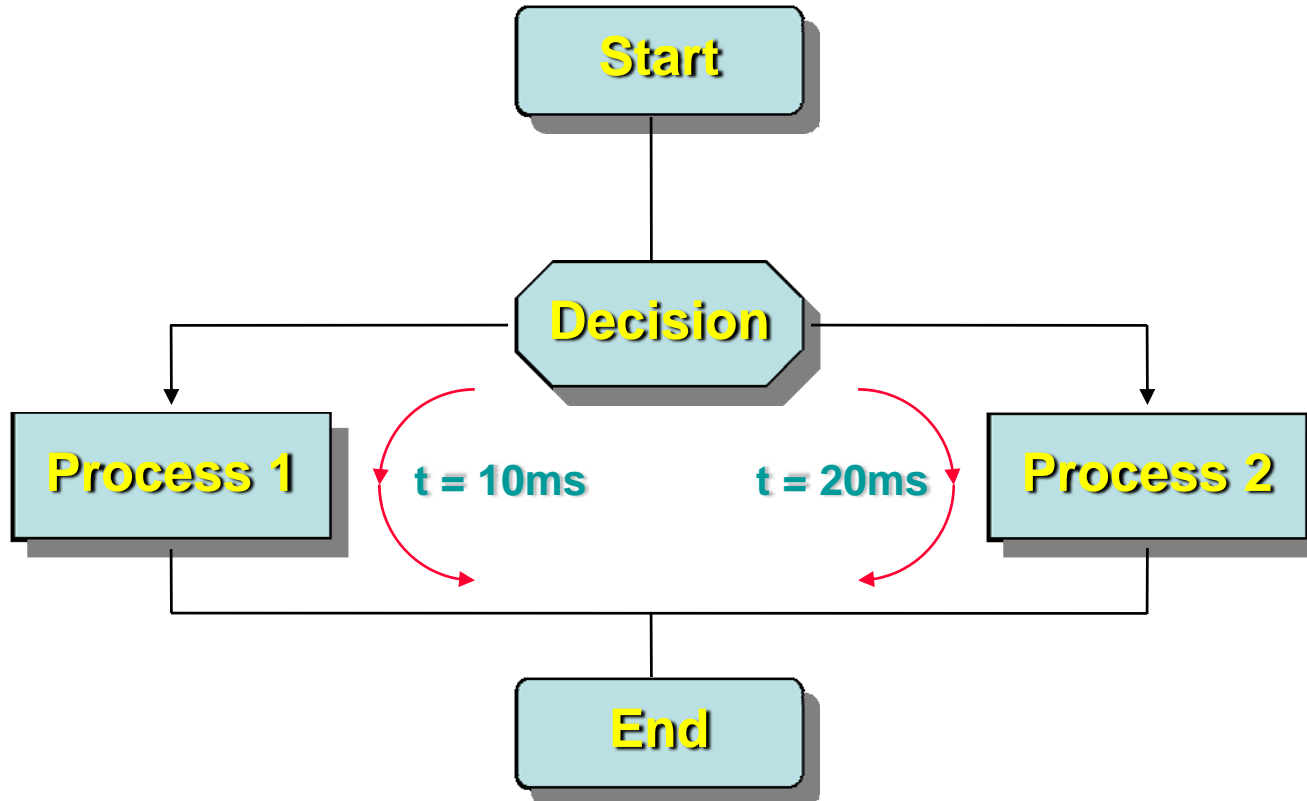

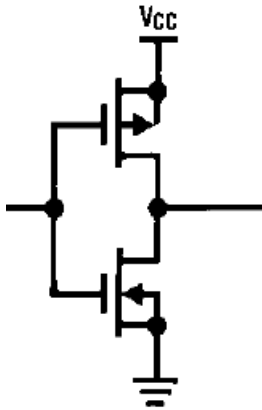

- Semiconductors use current while **switching**
- **Shape** of power consumption profile reveals activity
- **Comparison** of profiles reveals processes and data
- Power is consumed when switching from $1 \rightarrow 0$ or $0 \rightarrow 1$

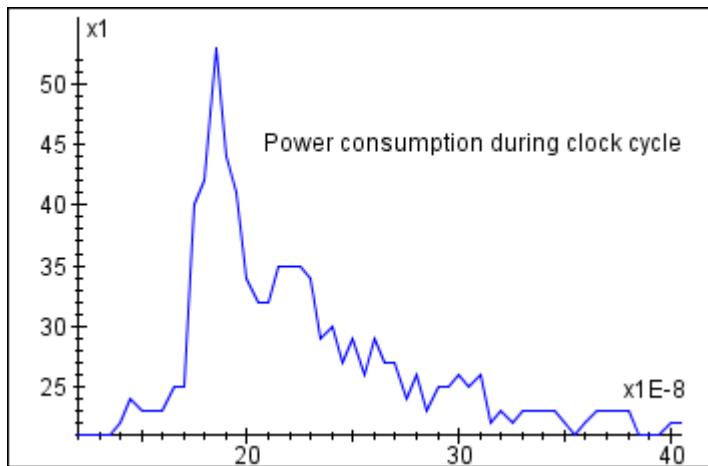

Principle of electromagnetic analysis

- Electric and Magnetic field are **related** to current
- Probe is a **coil** for magnetic field
- Generally the **near field** (distance $\ll \lambda$) is most suitable
- Adds **dimension position** compared to the one dimensional power measurement

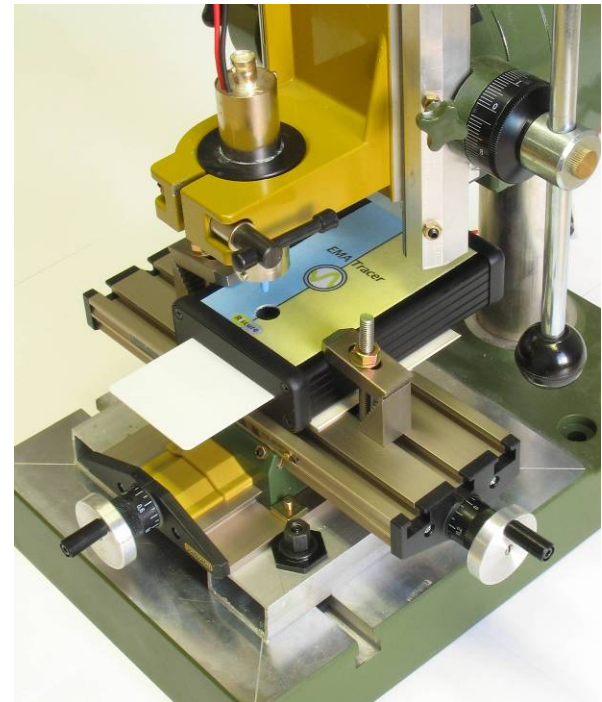
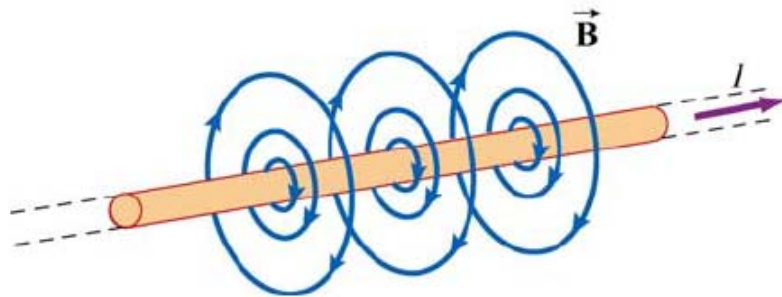

- Probes
 - Power: Intercept power circuitry with small resistor
 - EM: Coil with low noise amplifier
- Digital storage oscilloscope
- High bandwidth amplifier
- Computer with analysis and control software

XY table for EM analysis

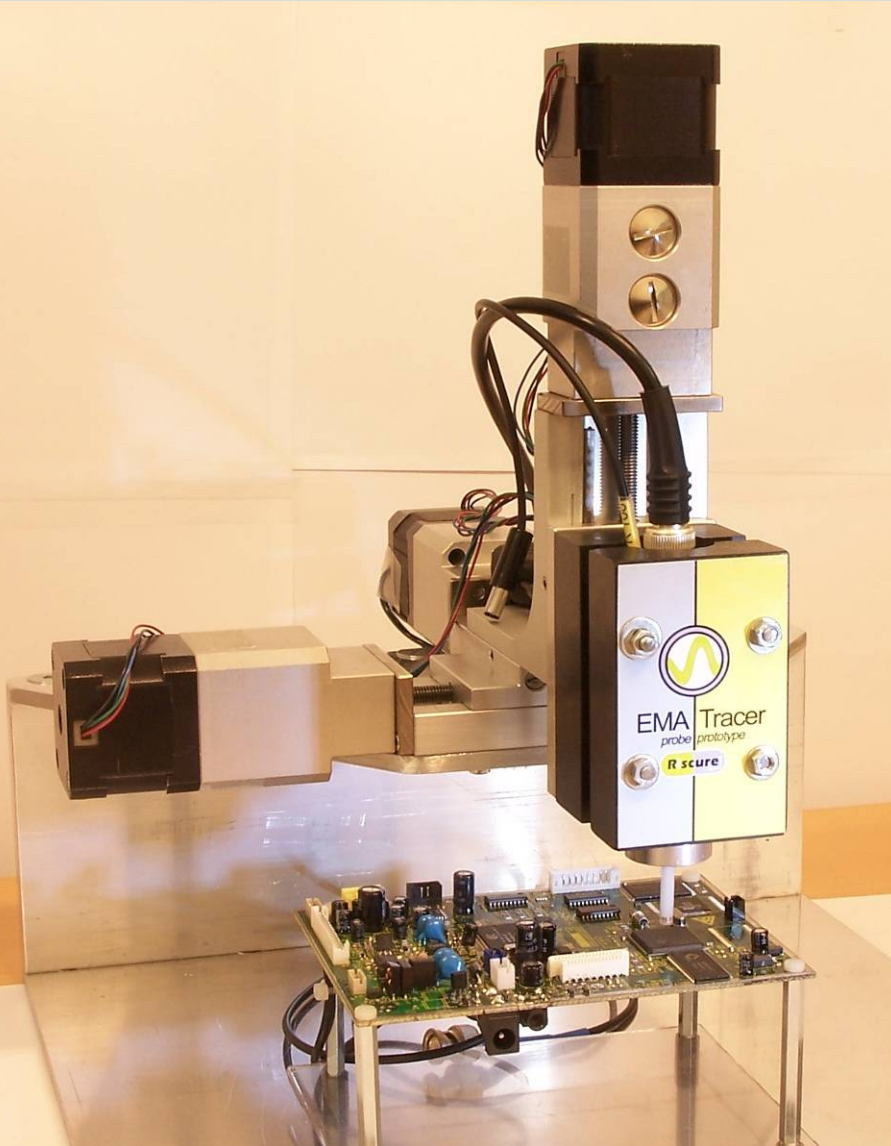

- Scanning chip surface with XY table
- Display intensity per frequency
- Search for optimal location:
 - CPU frequency
 - Crypto engine clock
 - RAM bus driver

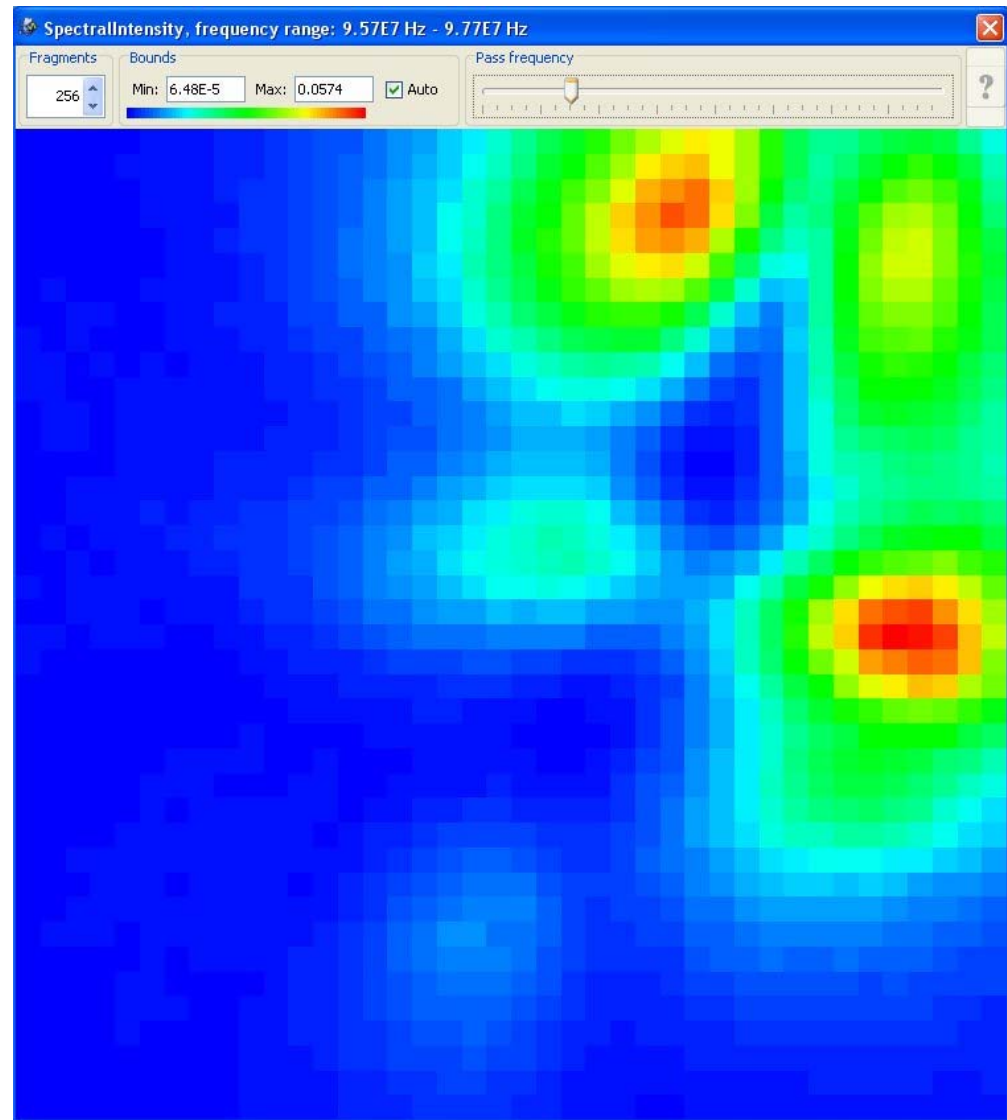

Demo equipment



- CPU: Ti OMAP 5910 150Mhz

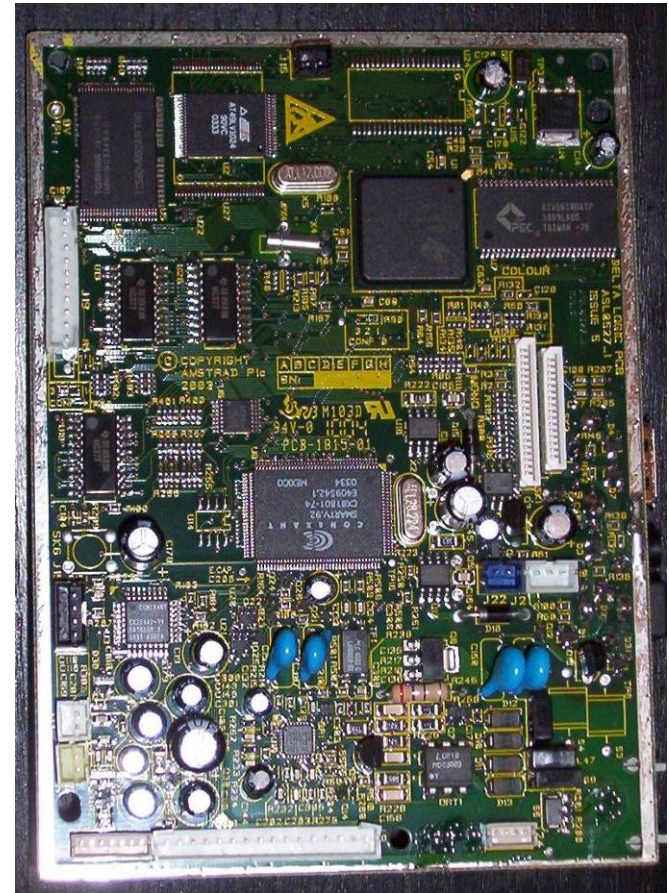

Listening to your hardware - demo

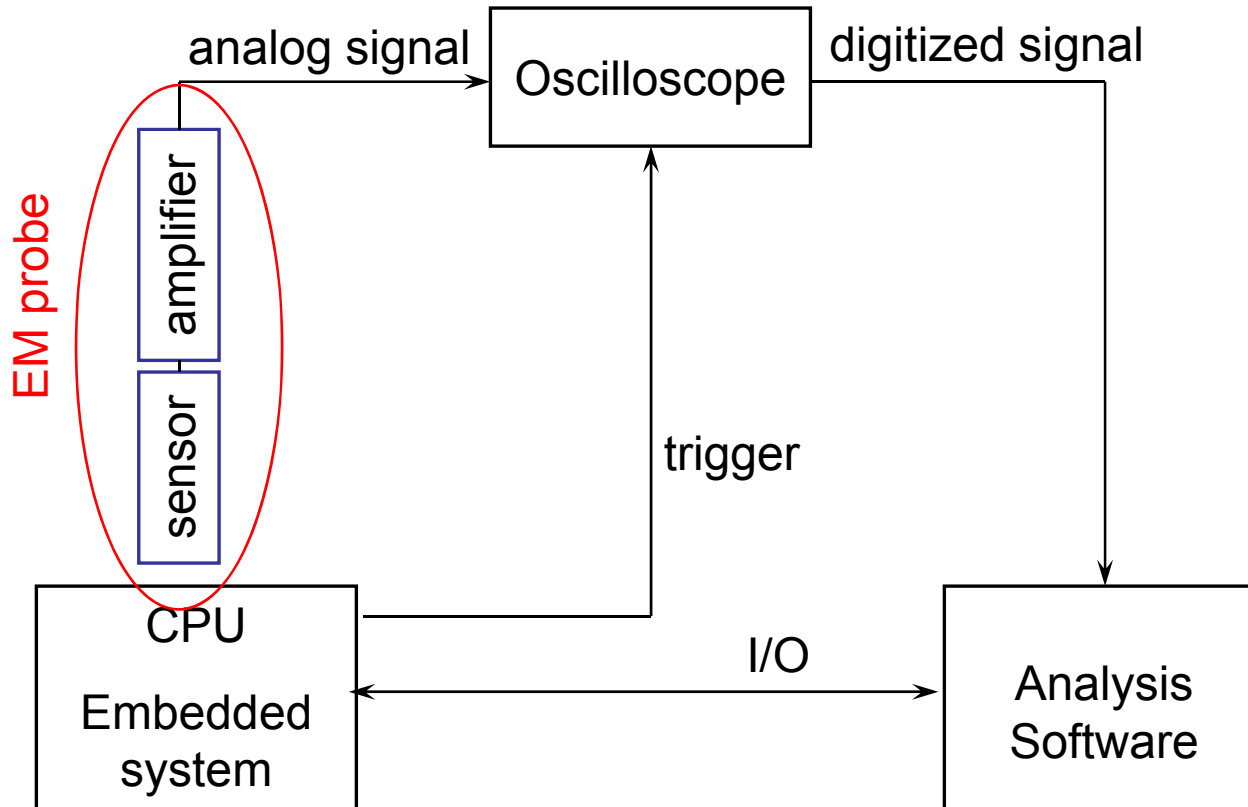

Simple Power/EM Analysis

- Recover information by inspection of **single or averaged** traces
- Can also be useful for **reverse engineering** algorithms and implementations

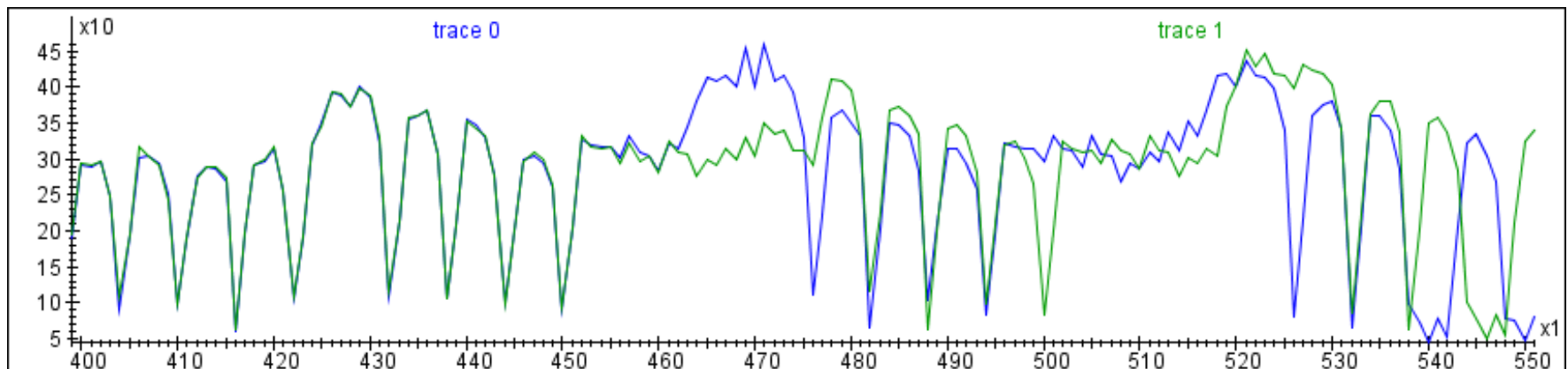
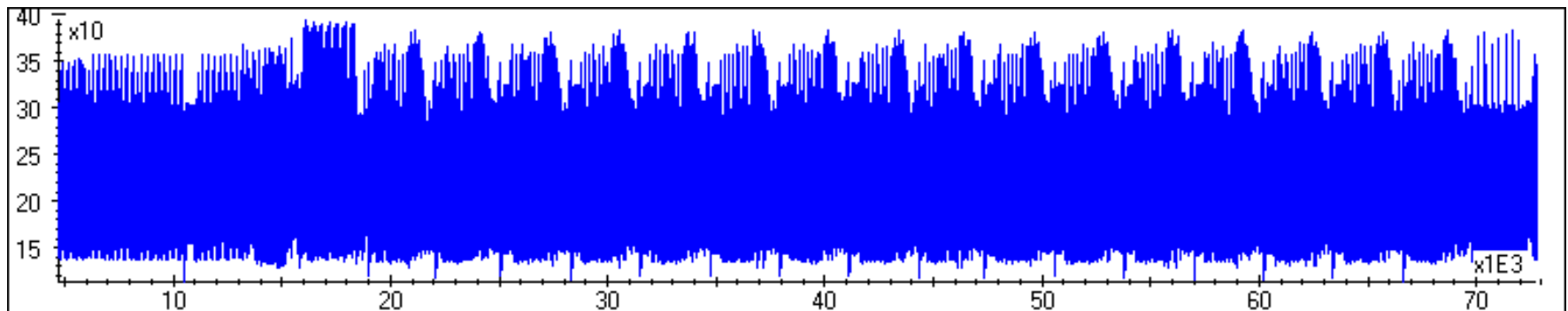

Differential Power/EM Analysis

- Recover information by inspection **difference** between traces with different (random) inputs
- Use **correlation** to retrieve information from noisy signals

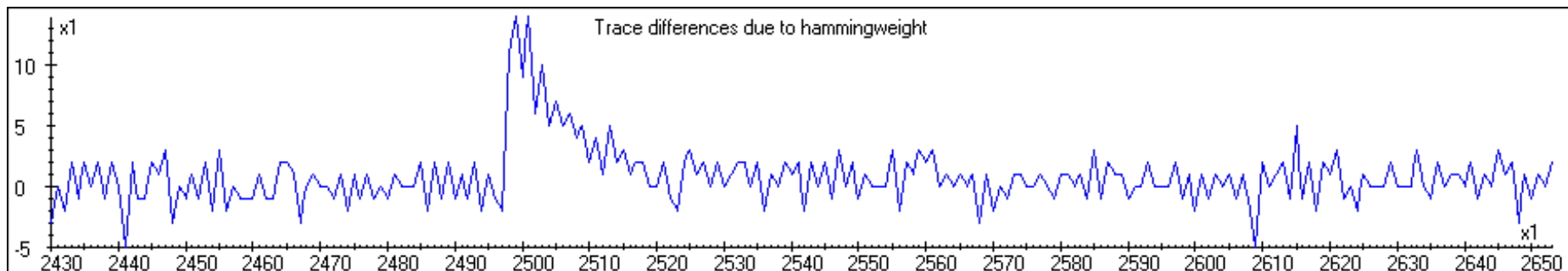
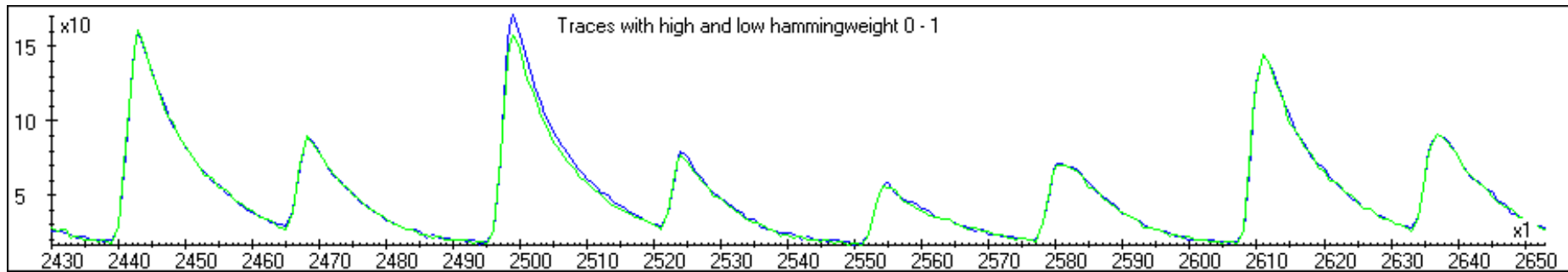

Data/signal correlation

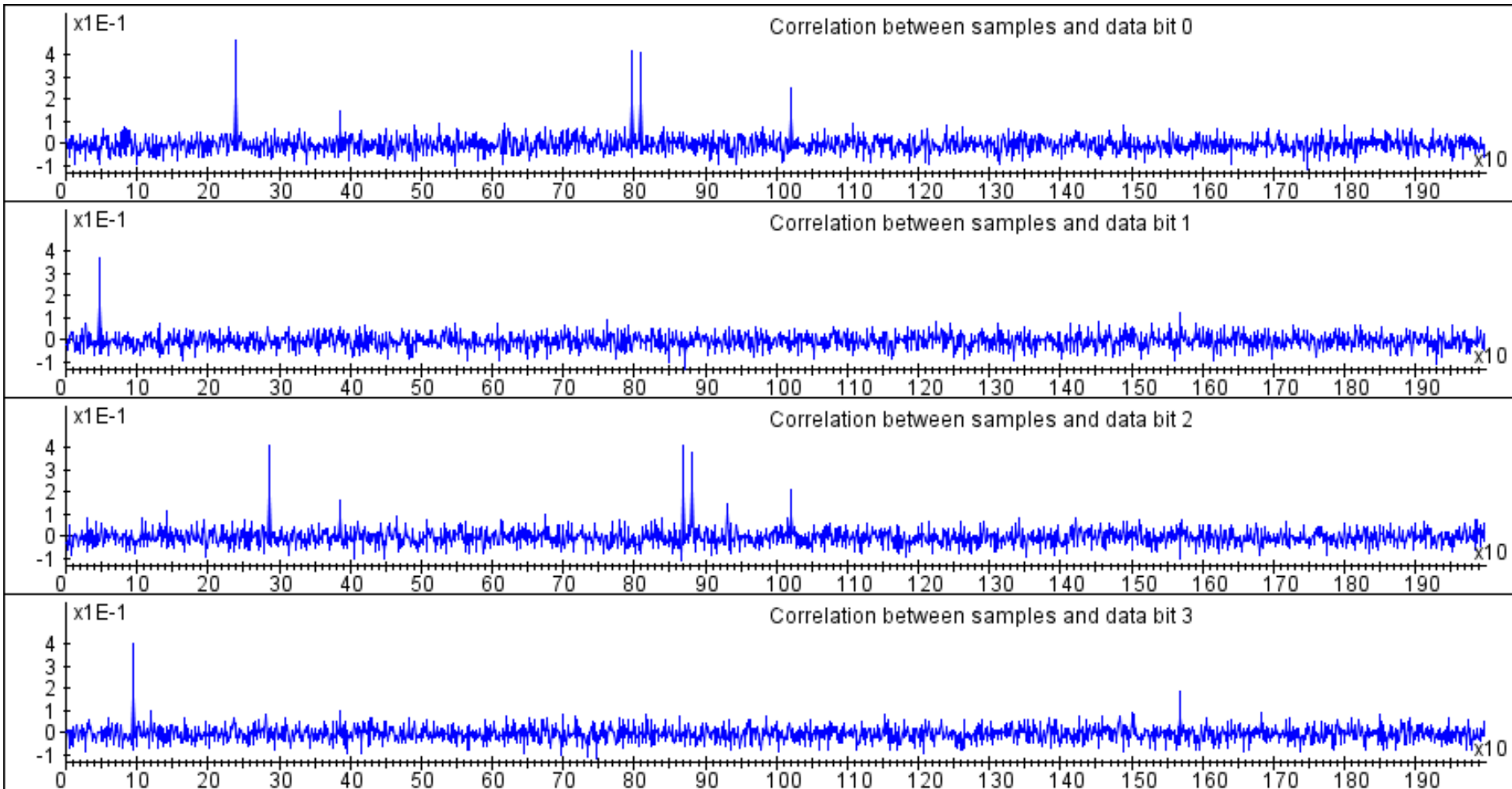

- Advances in Embedded Systems Security
 - From USB stick to game console
 - Current attacks
 - Cryptographic devices
- Side Channels explained
 - Principles
 - Listening to your hardware
 - Types of analysis
- **Attacks and Countermeasures**
 - Breaking a key
 - Countermeasures theory
 - Practical implementations

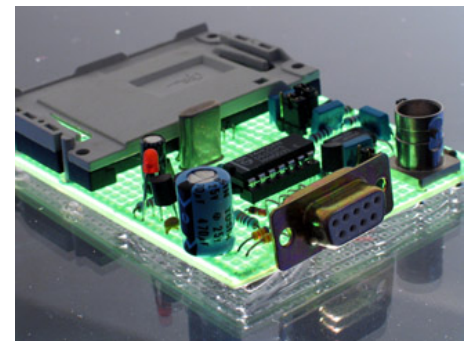

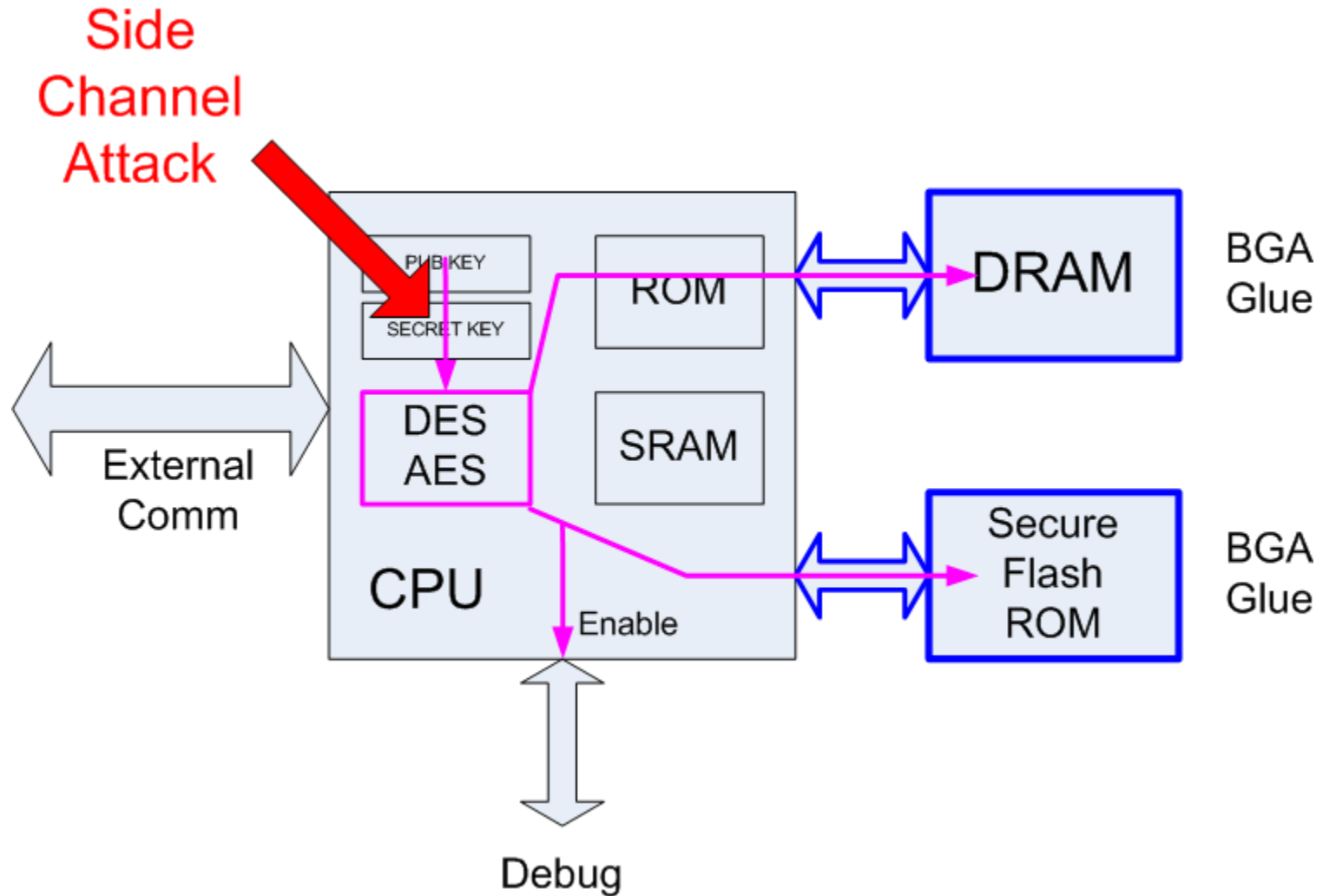

- Example breaking a DES key with a differential attack
- Starting a measurement
- Explaining DES analysis
- Showing results

DES

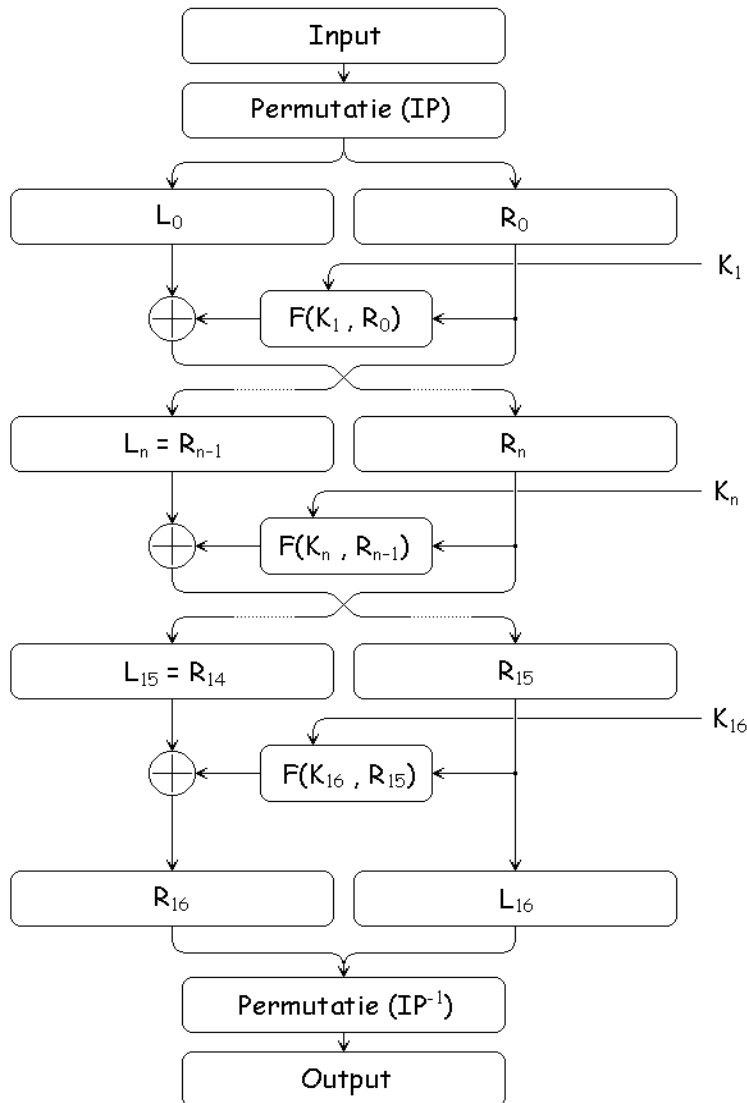

16 rounds

- Input and output are 64 bits
- Key K is 56 bits
round keys are 48 bits
- Cipher function F mixes
input and round key

F- function

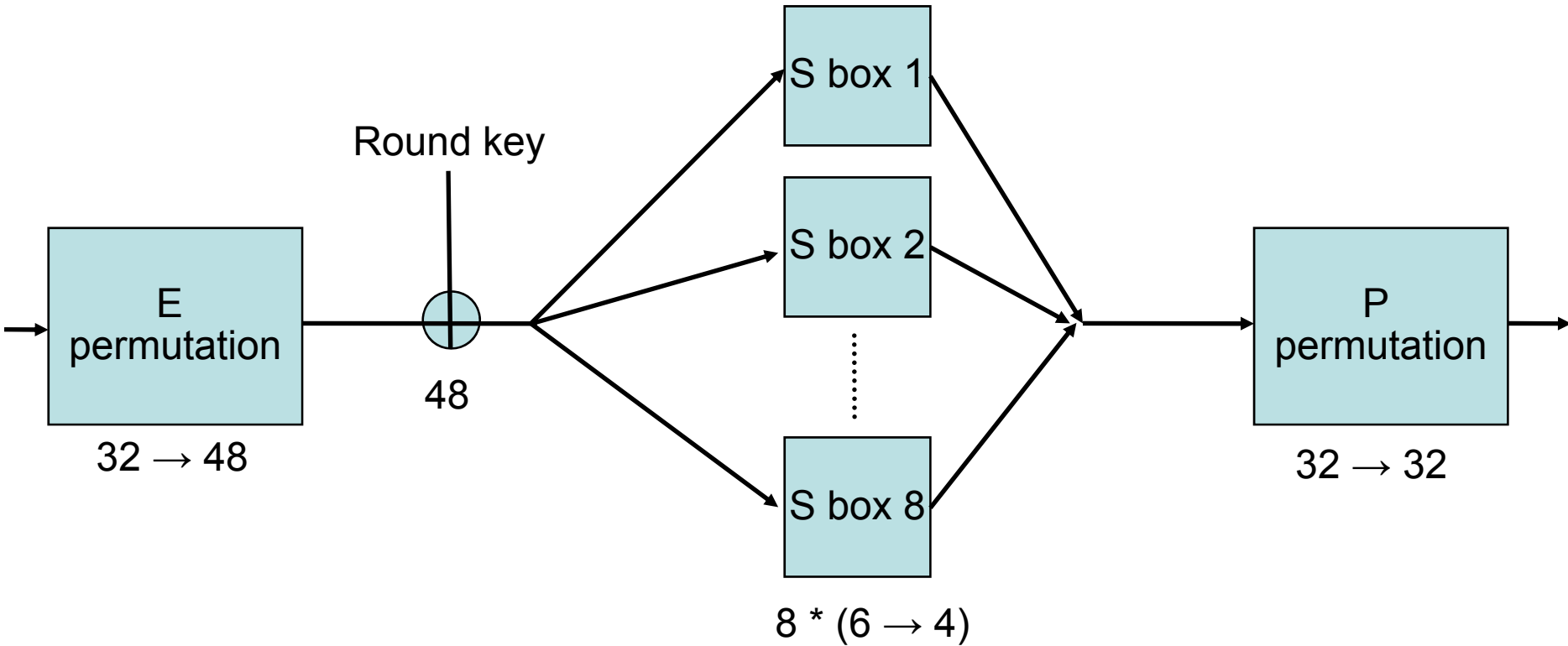

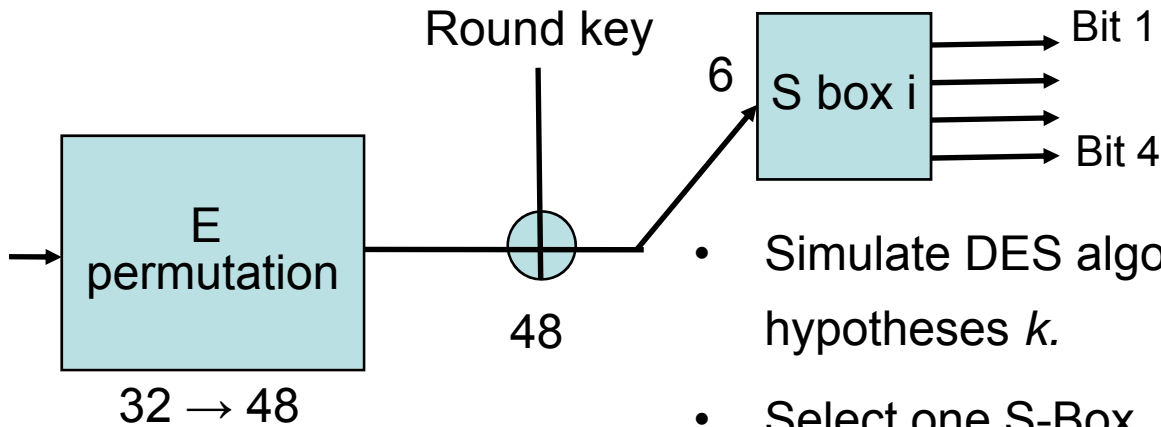

- Simulate DES algorithm based on input bits and hypotheses k .
- Select one S-Box, and one output bit x . Bit x depends on only 6 key bits.
- Calculate differential trace for the 64 different values of k .
- Incorrect guess will show noise, correct guess will show peaks.

DPA on DES results

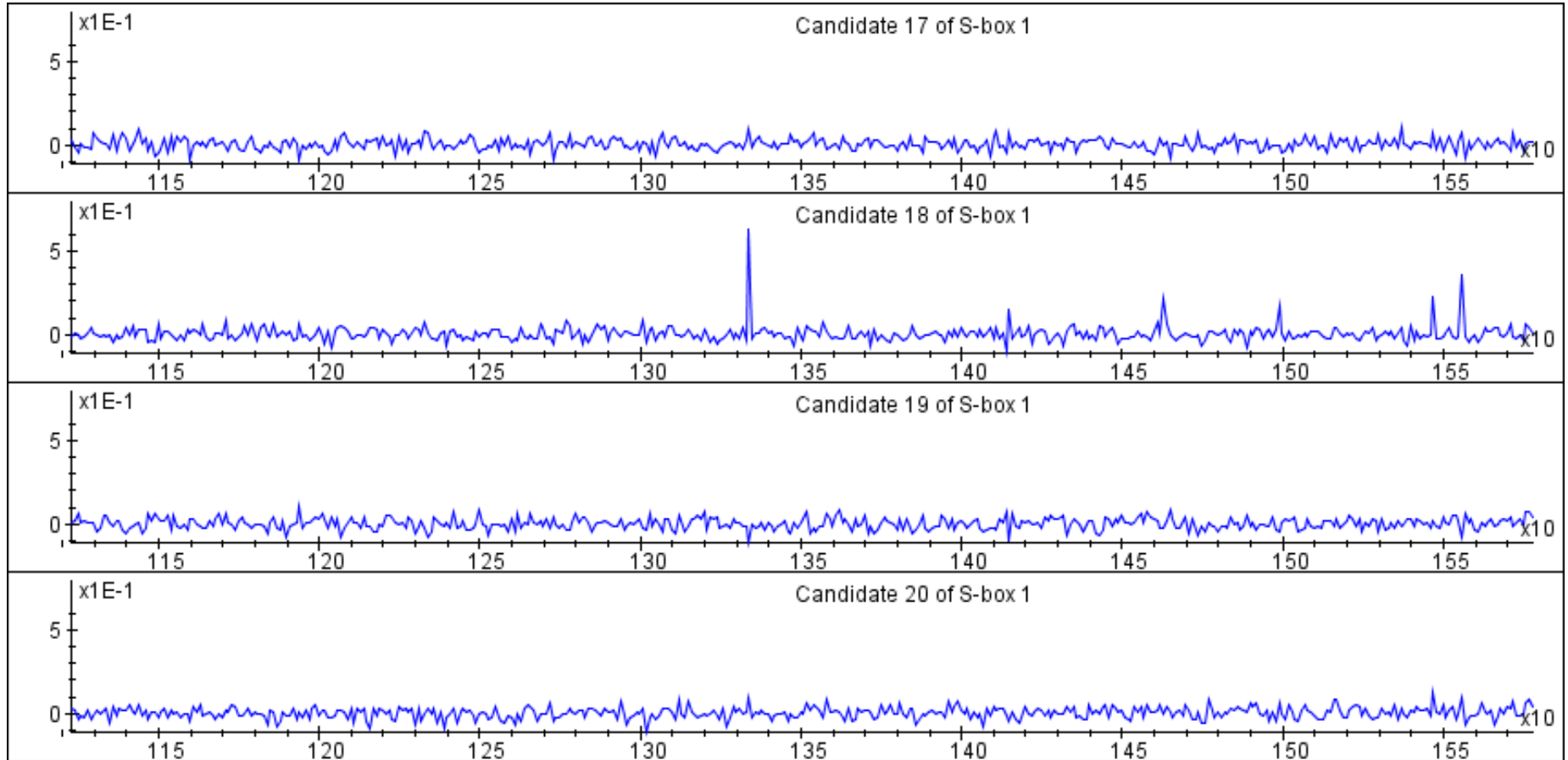

- **Decrease** leakage
 - Balance processing of values
 - Limit number of operations per key
- **Increase** noise
 - Introduce timing variations in processing
 - Use hardware means

- Passive Side channel attacks:
 - **Hiding:**
Break relation between processed value and power consumption
 - **Masking / Blinding:**
Break relation between algorithmic value and processed value

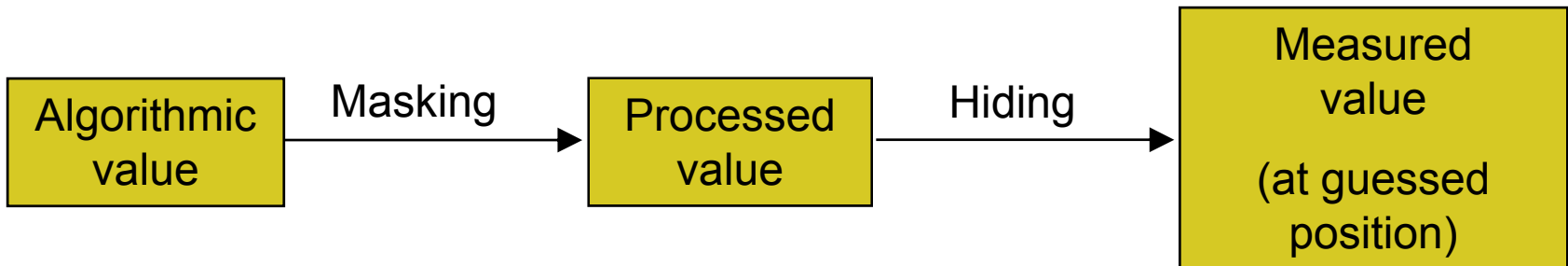

- **Change the crypto protocol** to use key material only for a limited amount of operations. For instance, use short lived session keys based on a hash of an initial key.

Example:

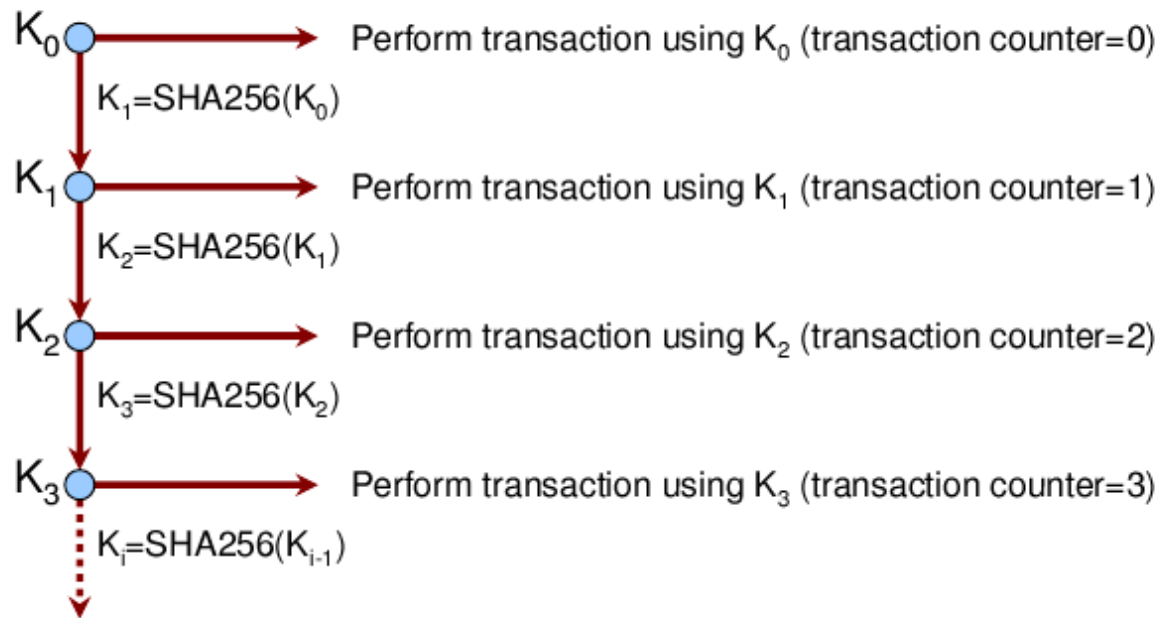

Source: Kocher, P. *Design and Validation Strategies for Obtaining Assurance in Countermeasures to Power Analysis and Related Attacks*

Countermeasure examples

- Remove any execution **time dependence** on data and key. Do not forget cache timing and branch prediction. Also remove **conditional execution** that depends on the key.
- **Randomly insert instructions** with no effect on the algorithm. Use different instructions that are hard to recognize in a trace

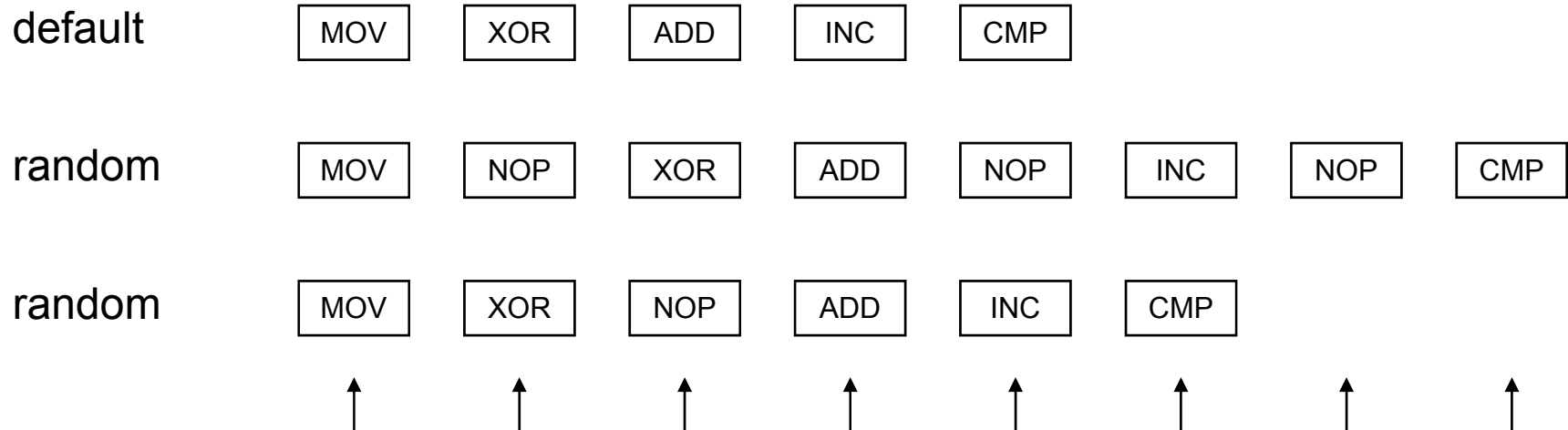

- Shuffling: **Changing the order** of independent operations (for instance S-box calculations) per round. This reduces correlation with a factor equal to the number of shuffled operations

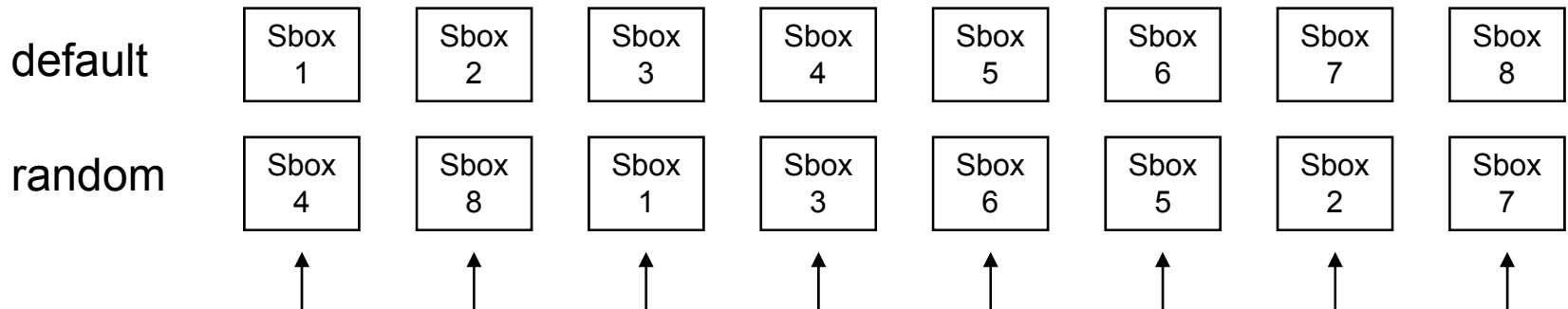

- Implement a **masked** version of the cryptographic algorithm. Examples can be found in research literature for common algorithms (RSA, AES).

- Simple analysis of unprotected trace
- Effect of randomly inserting NOP instructions
- Effect of making RSA square-multiply constant

SPA attack on RSA

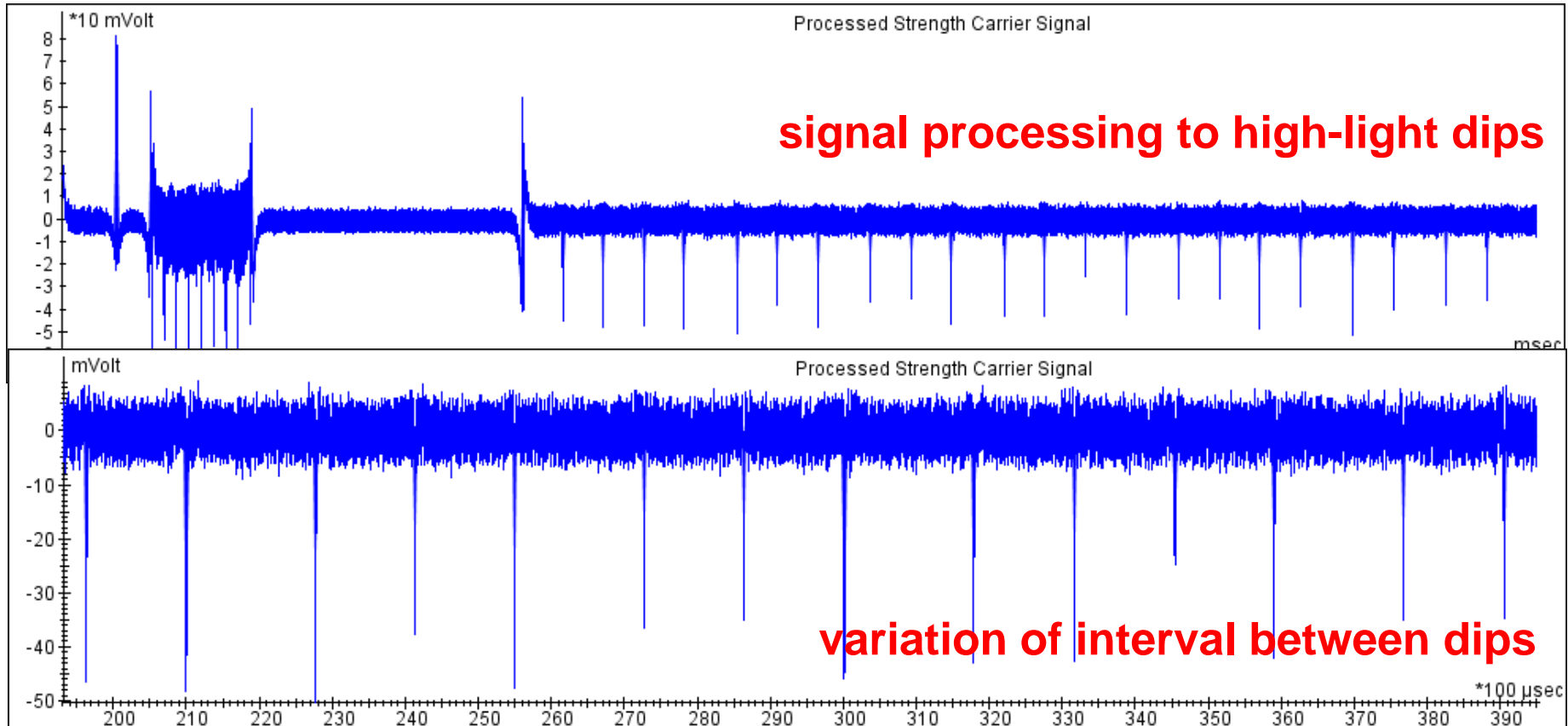

1 0 1 0 1 0 0 1 0

key bits revealed

- Algorithm for $M=c^d$, with d_i is exponent bits ($0 \leq i \leq t$)
 - $M := 1$
 - For i from t down to 0 do:
 - $M := M * M$
 - If $d_i = 1$, then $M := M * C$
- Algorithm for $M=c^d$, with d_i group of exponent bits ($0 \leq i \leq t$)
 - Precompute multipliers C^i
 - $M := 1$
 - For i from t down to 0 do:
 - For $j = 1$ to groupSize: $M := M * M$
 - $M := M * C^i$

Example: RSA message blinding

- Normal encryption: $M = C^d \bmod n$ under condition:
 - $n = p \cdot q$
 - $e \cdot d = 1 \bmod \text{lcm}(p-1, q-1)$
- Choose a random r , then $C_r = C r^e \bmod n$
- Perform RSA: $M_r = C_r^d \bmod n = C^d r \bmod n$
- $M = M_r r^{-1} \bmod n$

- During the RSA operation itself the operations with exponent d do not depend on C

- The best way to understand side channel leakage is **to measure** your own implementation
- Side channels analysis can be performed on a device to **assess its level of vulnerability** to such attacks
- Such analysis is part of **certification processes** in the payment industry and in Common Criteria evaluations.
- **FIPS 140-3** will require side channel testing for certain levels

- DPA attacks were first published by **Paul Kocher** et al. from Cryptography Research, Inc. (CRI)
- A large range of countermeasures are **patented** by CRI and other companies
- CRI **licenses** the use of them
- The patents give a good idea of possible countermeasures, check with CRI

- With the increase of security features in embedded devices the importance of **side channel attacks** will also increase
- Most of these devices with advanced security features do **not yet** contain hardware **countermeasures** against side channel attacks
- Side channel attacks present a **serious threat** with wide range of possibilities and a large impact
- Still, software developers can **reduce the risks** of side channel attacks by securing their implementations with software countermeasures

Job de Haas

dehaas@riscure.com

1. Joe Grand, "Advanced Hardware Hacking Techniques", Defcon 12
http://www.grandideastudio.com/files/security/hardware/advanced_hardware_hacking_techniques_slides.pdf
2. Josh Jaffe, "Differential Power Analysis", Summer School on Cryptographic Hardware
<http://www.dice.ucl.ac.be/crypto/ecrypt-scard/jaffe.pdf>
<http://www.dice.ucl.ac.be/crypto/ecrypt-scard/jaffe2.pdf>
3. S. Mangard, E. Oswald, T. Popp, "Power Analysis Attacks - Revealing the Secrets of Smartcards"
<http://www.dpabook.org/>
4. Dan J. Bernstein, "Cache-timing attacks on AES",
<http://cr.yp.to/papers.html#cachetiming>, 2005.
5. D. Brumley, D. Boneh, "Remote Timing Attacks are Practical"
<http://crypto.stanford.edu/~dabo/papers/ssl-timing.pdf>
6. P. Kocher, "Design and Validation Strategies for Obtaining Assurance in Countermeasures to Power Analysis and Related Attacks", NIST Physical Security Testing Workshop - Honolulu, Sept. 26, 2005
<http://csrc.nist.gov/cryptval/physec/papers/physecpaper09.pdf>
7. E. Oswald, K. Schramm, "An Efficient Masking Scheme for AES Software Implementations"
www.iaik.tugraz.at/research/sca-lab/publications/pdf/Oswald2006AnEfficientMasking.pdf
8. Cryptography Research, Inc. Patents and Licensing
<http://www.cryptography.com/technology/dpa/licensing.html>